

Chandler Workspace SA 140003-083/PQ

Artopex

Category 1- Workstation Systems

- Axel
- Accessories
- Axel Beam

Category 2 - Work Surface Products

- Take Off
- Take Off Adjustable Tables

Category 3 - Filing and Storage Products

- Take Off
- Metal

Category 4 - Phone Booths and Pods

- SC Lounge

Category 5 - Ancillary Products

- Express Program
- Accessories
- Take Off

Category 6 - Collaborative Products

- Take Off Conference
- Downtown
- Genius Tables
- Accessories
- Seating/Lounge
- Take Off

AXEL

Systems Furniture



artopex®

AXEL

An open mind

Collaboration

Flexibility

Privacy

Compatibility

Modularity

Acoustic

AXEL

A solution for open spaces

General Highlights

1

Axel offers innovative workstation configurations that naturally combine individual and collaborative work.

2

Pavilions allow to design meeting zones, respite rooms, private office, etc.

3

The extended choice of finishes (laminated, felt, acrylic and fabric) provides high design flexibility.

4

Ambient noise management is improved with the acoustic fabric and felt tiles, and the slatted ceilings with acoustic felt.

5

Axel offers efficient electrical wiring and cable management.

6

A new Grade A fabric card, available at competitive prices, is now offered to customize tiles.



AXEL

A solution for open spaces

Product flexibility

1 Stackable frames

Stackable frames available to add to base frames to reach the maximum height of the 90" pavilions.

Base frame heights

30", 36", 42", 54", 66"

Stackable frame heights

12"

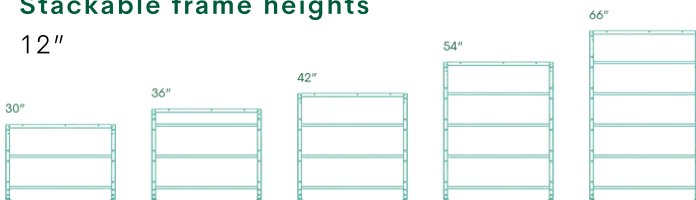

2 Tiles and frames

The adaptability and versatility of Axel's tiles and frames allow for a variety of configurations of the workspace.

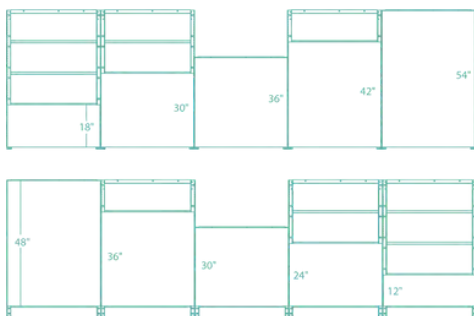

3 Technology integration

Attachment system with several holes can be used with a large variety of television mounting brackets.

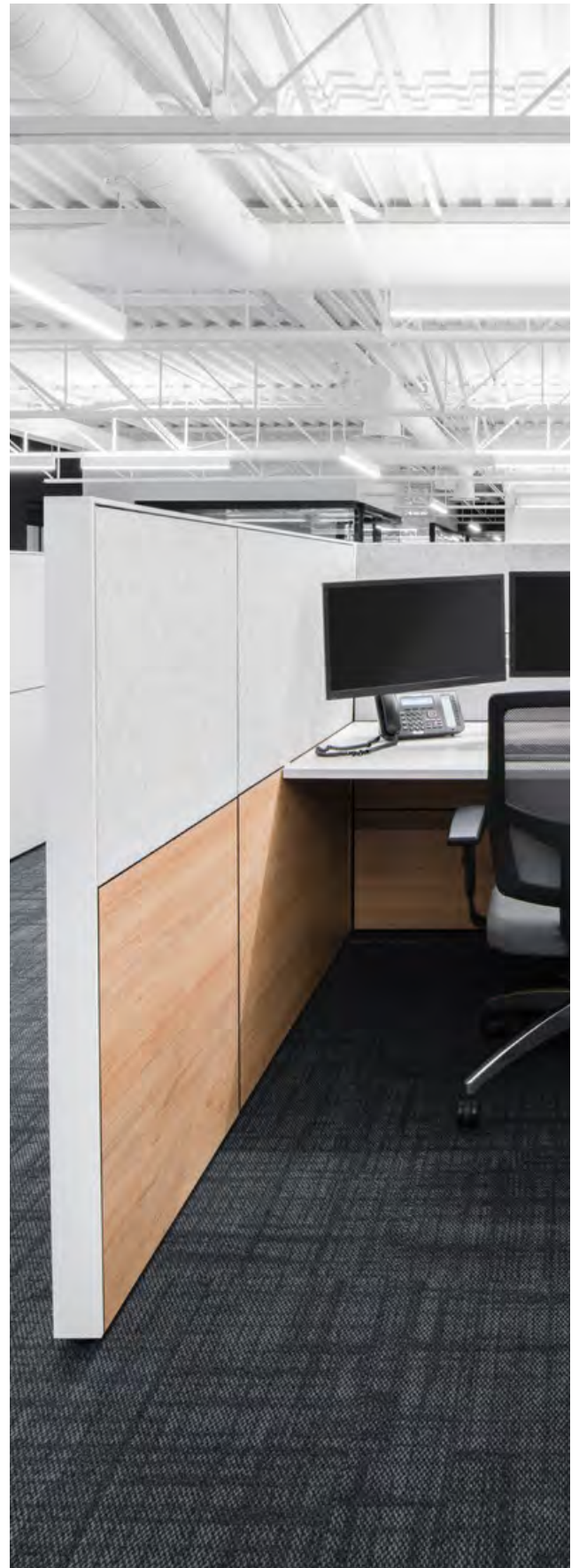

AXEL

A solution for open spaces

Product flexibility

4 Versatile materials

Base frames are assembled in steel to support various sizes of tiles in different materials such as laminate, fabric, acoustic felt, and tackable fabric.

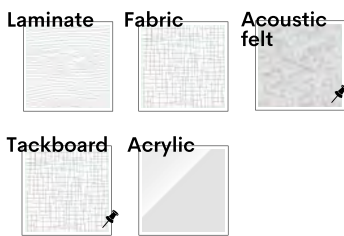

All Artopex finishes are available for this collection.

5 Electrical outlets

There are 3 levels of height positions for the use of electrical and communications outlets.

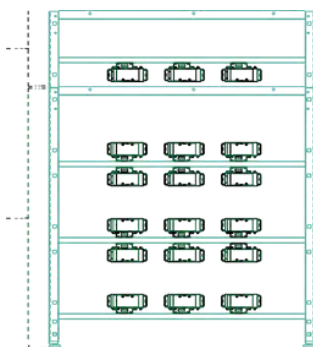

C - On top of surface

B - Under surface

A - Ground level



AXEL

A solution for open spaces

Electrical System

Circuit flexible electrical system.
Power through the base or by cable
pole.

USB outlets on panels available.

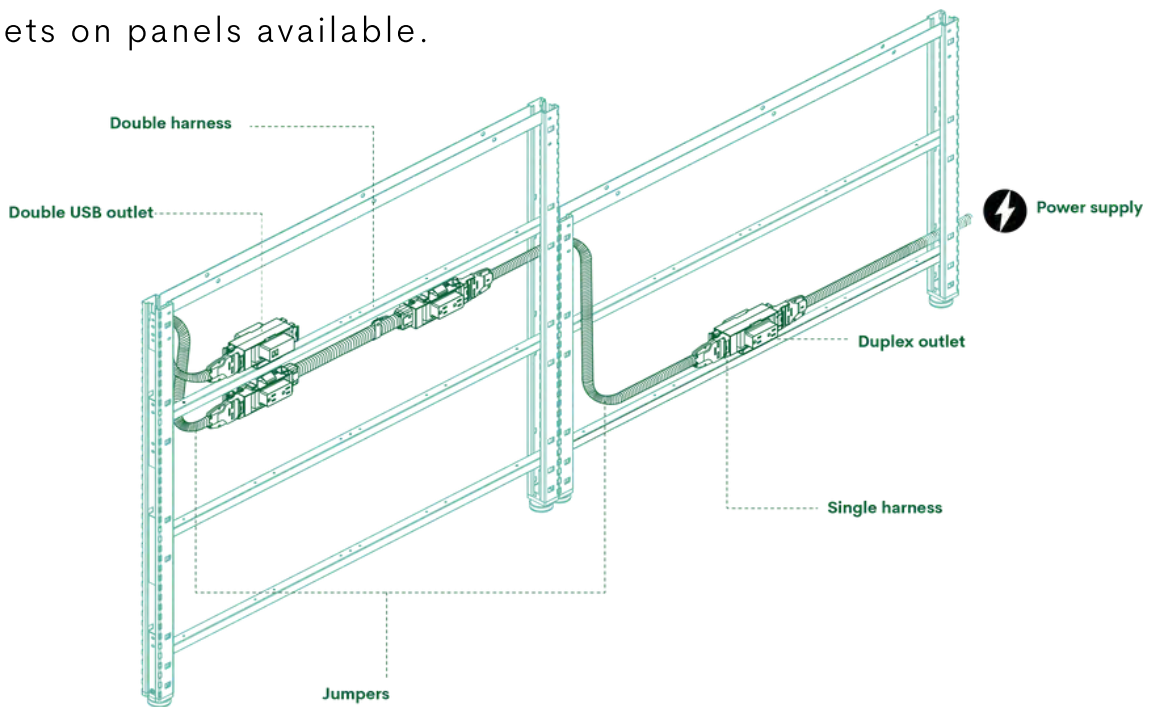

AXEL

A solution for open spaces



Axel workstation and multimedia meeting room with laminate tiles.



Workstations with laminate panels, straight profile leg and glass privacy screens inserted into the structure.

AXEL

A solution for open spaces



Combined workstations: individual workstation and collaborative space. Open frame with rounded shelves.



Workstations with laminate panels and laminate tiles pavilions.

AXEL

A solution for open spaces



120-degree workstations.



Individual workstation with acoustic fabric tiles.

AXEL

A solution for open spaces



Axel workstations with adjustable tables and surface multi-outlets to create nomadic workstations.



Axel lounge pavilion.

Adjustable Desks
Take Off





Refined furniture distinguished by its design and height adjustment system, concealed with great elegance.

Refined design

Our Take Off adjustable desks collection: a refined design combining aesthetics, ergonomics, and high quality for impeccable furniture.

Storage-supported panels that are both decorative and practical, thanks to shelves with no visible hardware.



Wide range of storage options and components, 100% compatible with the current Take Off line.



Adjustable column cover, finishing plate for storage unit



Full-width leg with multiple finish options, concealing a proven lifting mechanism.



Storage-supported panel can be specified in laminate, felt (with or without decorative grooves), or fabric.



Elegant «pillar» metal leg, available in the full range of Artopex enamel finishes.

Ingenuity

Our adjustable desks optimize your workspace with a proven height adjustment mechanism, practical storage options, and storage-supported panels available in a variety of finishes. Hassle-free cable management for electrical and communication wiring is made possible through multiple designated wire troughs and channels.

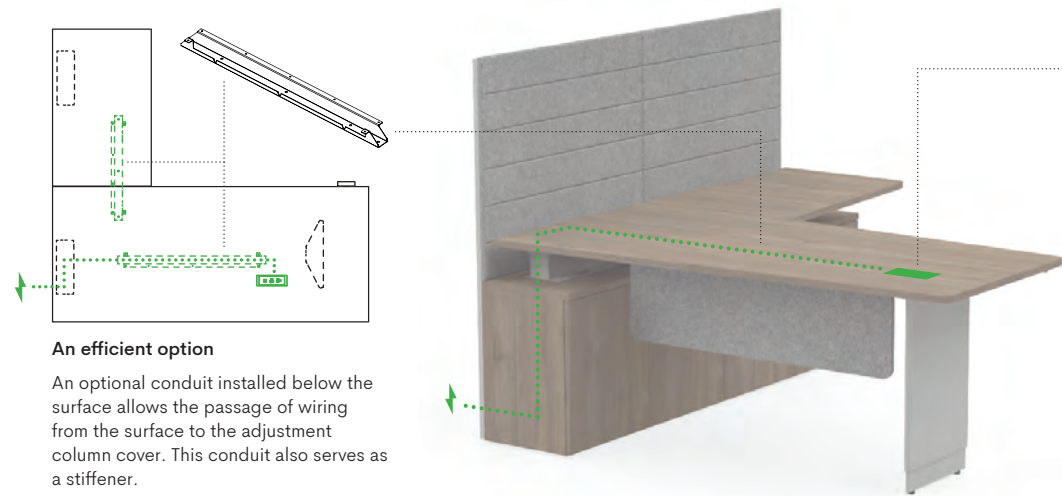

Easy connection
Grommets or multi-outlet modules (4 models) can be specified on the surface.



An efficient option
An optional conduit installed below the surface allows the passage of wiring from the surface to the adjustment column cover. This conduit also serves as a stiffener.

Ingenious storage
Storage with space at the back concealing the adjustment column and allowing for wiring passage. A back panel can be specified for a neat finish.



Removable inner back panel (attached with magnets) allowing access to the adjacent wall and facilitating cable management.



Simplified specifications

Selection of configurations with components thoughtfully grouped together, making it easier to specify a layout.

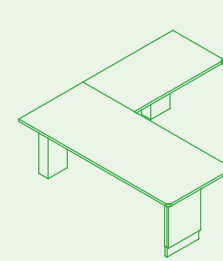

Desk

The desks are specified in pre-established configurations including surface(s), leg(s), and adjustable column(s).

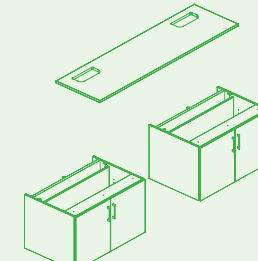

Storage units

Wide range of storage options, with or without space at the back allowing for the passage of the adjustable column. Tops also specified separately for greater customization.

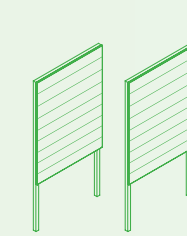

Storage-supported panels

As a convenient option, the storage-supported panel is available in multiple formats and finishes. It can be specified for furniture from the Take Off collection.



Digital keypad

Multifunctional digital keypad for a surface adjustment range between 26 1/8" and 47 1/2" in height. Programming up to four positions is possible.

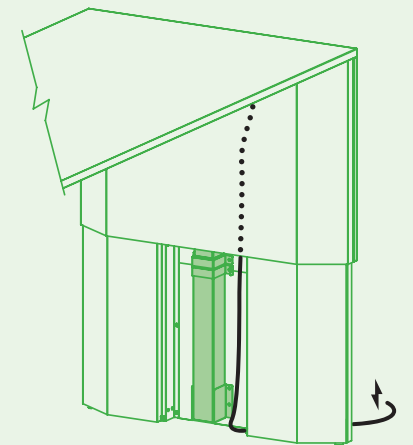

Concealed cabling

Practical components such as the under-surface stiffener and leg cover allow discreet routing of wiring to the wall or floor source.

Infinite configurations

Available in a wide range of components, this collection combines elegance and functionality to create a stylish and efficient workspace!



White laminate and Grigio Bromo H.P.L.
White enamel



Lago and Frost laminates
Frost enamel and Storm felt



Frost and Tobacco Cherry laminates
Grigio Bromo enamel



White and Sheer Beauty laminates
White enamel and Dune felt



Sheer Beauty and White laminates
Navy enamel



White and Dalia laminates
Polar White enamel and Dune felt



Free Spirit laminate
China Blue enamel



White and Free Spirit laminates
Polar White enamel

Downtown
Collaborative Furniture



artopex®

Waiting Area

With a wide variety of shapes, dimensions and back styles, Downtown seating can be used to create countless layouts. Choose your favorite style for the back, offset from seat end, or full-width for a seamless side-by-side arrangement.



Backrest offset

Round occasional table

Ottoman

Round ottoman

Upholstered table with laminated top

Armrest

Meeting Room

Take a seat around a bistro Mediacom table for a productive meeting. Specially designed to mount a monitor screen and to manage cabling efficiently, the tables come equipped with a cutting-edge linked communication system to facilitate the sharing of ideas and information.



Downtown
Mediacom bistro table in Douglas Pine laminate.

Furniture
Blitz stools and Vortex office chair.

Café Area

Bistro-height tables fit perfectly into collaborative areas for spontaneous encounters or even in a cafeteria for a coffee break.



Downtown
Bistro tables in White laminate with recessed multi-outlet.
Furniture
Crema stools.



The fabric upholstered tables provide the bench with a continuity aspect and can also be equipped with a laminate surface. An optional multi-outlet module is available with a duplex outlet and two USB charging ports for benches and upholstered tables.

Benches with backrests and upholstered table with laminated top.



The mobile white marker board is an essential tool for collaborative meetings and brainstorming sessions and can also be used to divide the space.

Mobile white marker board.



Privacy screens are available vertical, angled-top or with a shelf. Usually placed behind a seating unit, the fabric upholstered screens offer different degrees of privacy thanks to the three available heights.

Rectangular benches with multi-outlet on the side and backrests, angled-top privacy screens and bistro table.

Relaxed Meeting

Benches and ottomans are available in various shapes and sizes, allowing for configurations adapted to your needs. Combine benches with a Mediacom table to create a functional multimedia space for your team.



Downtown

Mediacom table with architectural base in Chestnut laminate, benches with backrests and open storage in White laminate.



Downtown
Ottoman and benches with half backrests.

Benches and Ottomans

Rectangular with half backrest

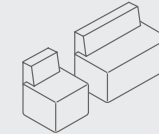

Rectangular with backrest

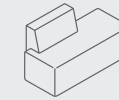

Rectangular with alternating backrests

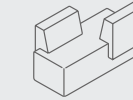

Square with corner backrest



Rectangular with corner backrest

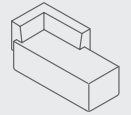

Rectangular with alternating corner backrests

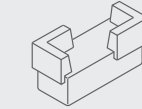

Trapezoid

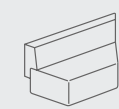

Curved



Round



Square and rectangular



Tables

Upholstered tables with laminate top



Occasional



Square, round and rectangular



Lounge



Collaborative work

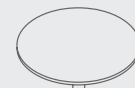

Mediacom



Mediacom bistro



Bistro



Complements

Privacy screen

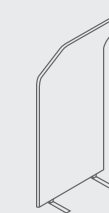

Screen with shelf



Mobile white marker board

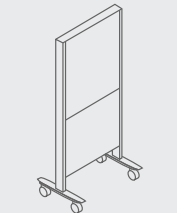

Mobile panel with Downtown connection



Storage units

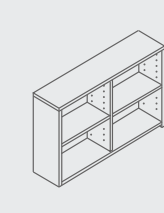

Tables

Meeting tables, Bistro tables,
Pub tables, conference tables,
occasional tables.



Productivity, in your image

A place for productivity, creation, and collaboration, meeting rooms can take many shapes to meet the constantly evolving needs of the workplace. The Take Off Conference collection offers a wide range of tables and storage modules to create inspiring spaces.



Meeting table

Willow Grey laminate round surface with Silver enamel tubular leg and round base plate.

Furniture

Frill chairs, White shells.

Time to relax

Create an ideal space for relaxation. Including various zones encourages interaction and promotes collaboration.



Tables

TakeOff Conference table with tubular legs and tabletop.

TakeOff table with angled legs.

Modular table with double "O" bases.

Modular table with disc base.

Chairs

Crema stool with seat and cushion.

Frill stool.

Fjord love seat with tubular base.

Upholstered Alexia chair.

Table Collection

The different shapes and heights of the Take Off Conference tables give you the freedom to design collaborative areas adapted to the needs of different group sizes. Match the legs with your chosen finish to create a meeting room that harmonizes with your layout!



Triangular meeting table

36W x 29H
Ginger Root laminate surface
Black enamel folded metal corner legs



Round meeting table

36 dia. x 29H
Tobacco Cherry laminate surface
Black enamel folded metal corner legs



Rectangular bistro table

24W x 60L x 41H
White laminate surface
Sheer Beauty laminate base



Capsule collaborative table

27W x 27L x 26H
Sheer Beauty laminate surface
Grigio Londra enamel base



Capsule collaborative table with "t" leg

30W x 42L x 26H
Sheer Beauty laminate surface
Grigio Londra enamel base



Capsule occasional table

13L x 21L x 26H
Sheer Beauty laminate surface
Black enamel base



Capsule occasional table

13L x 21L x 26H
Sheer Beauty laminate surface
White enamel base



Round occasional table

30 dia. x 16H
Fenix Matte Black surface
Black enamel "Fence" base



Oxalis triangular base trio

15W x 15L x 17H
18W x 18L x 15H
21W x 21L x 13H
Hypermat enamel surfaces and bases
(Nero Ingo, Grigio Bromo and Grigio Londra)



Round tables with tubular legs

24W x 24L x 18H
24W x 24L x 22H
Grigio Londra Fenix surface
Grigio Londra enamel base



Rectangular meeting table

36W x 84L x 29H
Sesame laminate surface
Polar White enamel folded metal corner legs



"Ovo" meeting table

42W x 84L x 29H
Fenix Matte Black surface, «V» edge
Angled wood legs, Natural finish



Square bistro table

42W x 42L x 36H
Dalia laminate surface
Black enamel "Cage" base



Pub table

30P x 60H x 41H
Sesame surface
Base: Bianco kos and China Blue

Power up your exchanges

The integration of built-in multi-outlets ensures efficient power cable management. The result: a functional space that accommodates technology.



Meeting table

Sesame laminate rectangular surface and Polar White enamel folded metal corner legs.

Furniture

Dotcom chairs and Polar White enamel metal lateral files.

Synergy

The Take Off Conference collection is ideal for cafeteria spaces. Thin and discreet table legs allow flexible chair organization.



Conference and meeting tables

Ginger Root laminate rectangular and square surfaces and Black enamel "T" tubular metal legs.

Furniture

Frill chairs and stools, Black shells.

The bistro height of this "Cage" base table encourages working standing up, quick discussions, and impromptu meetings.



Bistro table

Maritime Maple laminate square surface and Polar White enamel "Cage" base.

Furniture

White laminate Crema stools, Abyss enamel metal files and laminate wall panels with shelves and tackboard.

Classic look

Opt for a table with an architectural base and add some prestige to your meeting rooms. Timeless and classic, this base will set the tone for a sophisticated atmosphere.



Conference table

Carbon laminate surface with rectangular architectural bases .

Furniture

Vortex Mesh chairs.

Bistro table

The Bistro table can be used in several ways, either as a bistro table in cafeterias, as a conference table or as a Mediacom table. Its design and sturdy construction will make this table your go-to for many years.



Full Width "T" Leg

This type of base offers incomparable solidity, without stiffeners. For a distinct look, the leg can also be in a different color than the table.

Electricity

The wiring management is very subtle and is done through the end panel.



The mediacom bistro table encourages collaborative work, both on site and remotely, with its wall panel allowing the addition of a monitor.



Multiple configurations

The Bistro table can be specified in different widths, lengths and heights, allowing for integration into many different types.

The wall can be made wider and higher to suit your needs. A grommet can also be specified on the front for electricity.

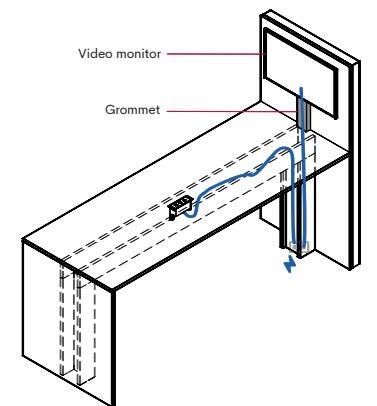

Electricity

The back of the wall can also be equipped with a metal frame, allowing for easy integration of electricity, with no visible hardware or wires!

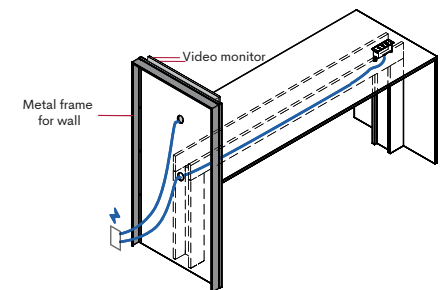

Pub table

A collection of Pub tables with multiple configurations!

Its base, available in all Artopex metal colors, can be specified in three different heights, offering great style flexibility with or without overhanging surfaces on two or four sides. Ideal for collaborative environments, it enables endless work configurations using adjacent bases.



Surface flush with the legs or overhanging.

A variety of configurations and components.

Cable management discreetly integrated into the leg.

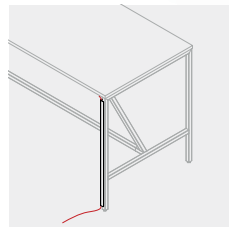

Robust due to its steel construction.

Adjacent leg allowing for a simple and streamlined junction.

Various heights for versatile use.



Possibility to color the components individually.



Pure elegance

Up to 192" in length, standard conference tables can welcome many participants during formal meetings. The aesthetics of this table's Fenix Matte Black combines elegance and timelessness.

Conference table

Fenix Matte Black laminate surface with rectangular architectural bases.

Furniture

Vortex Mesh chairs.



Sharing ideas

Socialization areas break up the rhythm of traditional offices and offer professionals a place for spontaneous meetings and collaboration. Integrating a Take Off Conference table into these spaces encourages knowledge-sharing and optimizes the emergence of new ideas.



Conference table

White laminate rectangular table with Black enamel tubular legs and round base plates.

Furniture

Frill chairs, Black shells and White laminate Crema stools.

Collaboration for better creation

Integrating Take Off Conference furniture creates practical environments where your teams will stay motivated and inspired. The modular table, with a clean design and natural wood legs, gives rise to a limitless creative space.



Meeting table
Round surface (Fenix H.P.L.) Nero Ingo, angled wood legs (Natural finish) with black metal supports.

Seating
Hanso chair.

It is possible to match surface shapes with different bases between each other.

Conference tables

Large tables including bases.

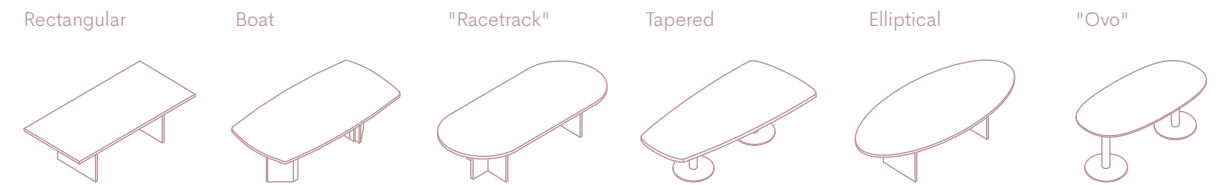

Meeting tables

Small tables including bases.



Modular tables

Small and medium sized tables created from surfaces and bases sold separately.



Bistro tables

Tables 26", 29", 35" or 41" high.
Wall panel 54", 66" or 72" high.
Various depths and widths.

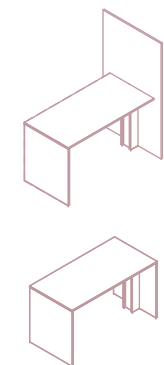

Occasional tables

Tables from 13" to 18" high including bases.

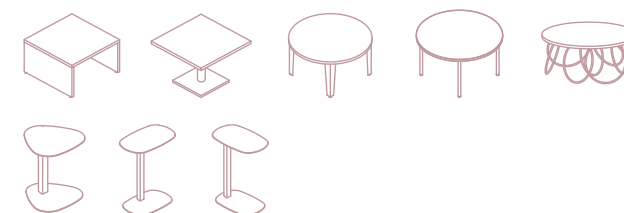

Pub tables

29", 36" or 41,5" high.
Laminate surface and metal base.

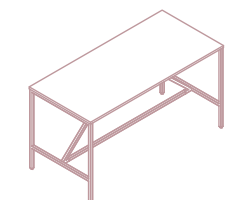

Legs

Angled wood legs,
Natural finish



Angled wood legs,
Black finish



Double "O" Techno base



Angled metal legs



Folded metal corner legs



"Cage" base



"T" tubular metal legs



Tubular legs, square or round



Tubular leg with base plate



X-base tubular metal leg



Bases

Rectangular or triangular architectural base,
straight or rounded corners, with or without metal



Panel base



X-laminate base



Work Walls

Upper work wall

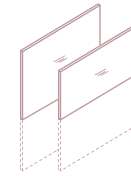

Lower work wall

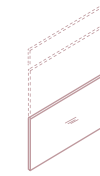

Configuration example

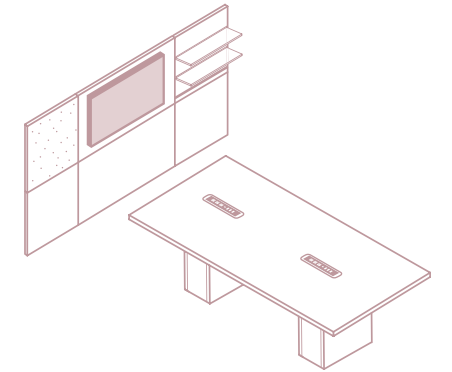

Laminate



1 accessory rail



3 accessory rails



White marker board

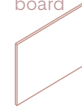

Tackboard

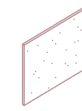

Cable Management

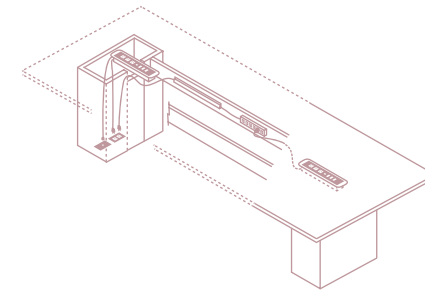
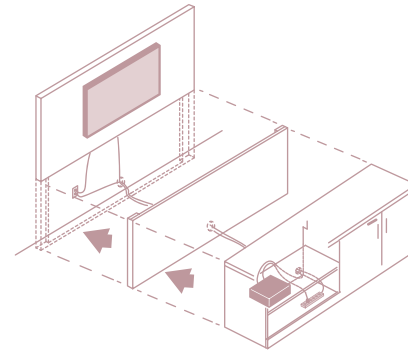

Genius
Training tables



LAZER EDGE

artopex®



Colorful

Visible metal components (legs, finishing caps, cable trays and metal doors) are available in all Artopex enamel finishes.



The Genius table collection is truly multi-purpose. They are available with fixed, flip-top or height-adjustable surfaces. Whether for training, conferences, business meetings or brainstorming sessions, Genius can be reconfigured in no time at all. The tables are designed to be nested vertically with ease and for wire management as needed.



Efficient Space Management



In storage position, flip-top tables occupy a minimum of space due to the unique interlocking leg system.

Legs and Footings

Two distinctly different leg styles are available on the Genius table with either levelers or casters. Flip-top tables are always equipped with casters for easy storage.

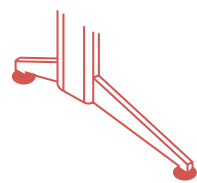

Contemporary leg with levelers

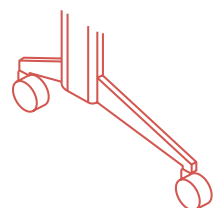

Contemporary leg with casters

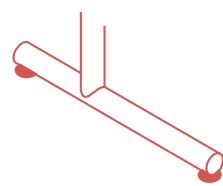

Tubular leg with levelers

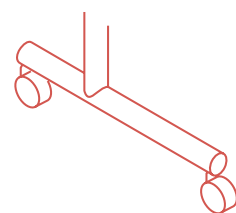

Tubular leg with casters

Power management

Four-circuit electrical system

- Allows for efficient wire management.
- Can be fitted with a flip access panel that also serves as a modesty panel.
- Easy access to outlets and other equipment.

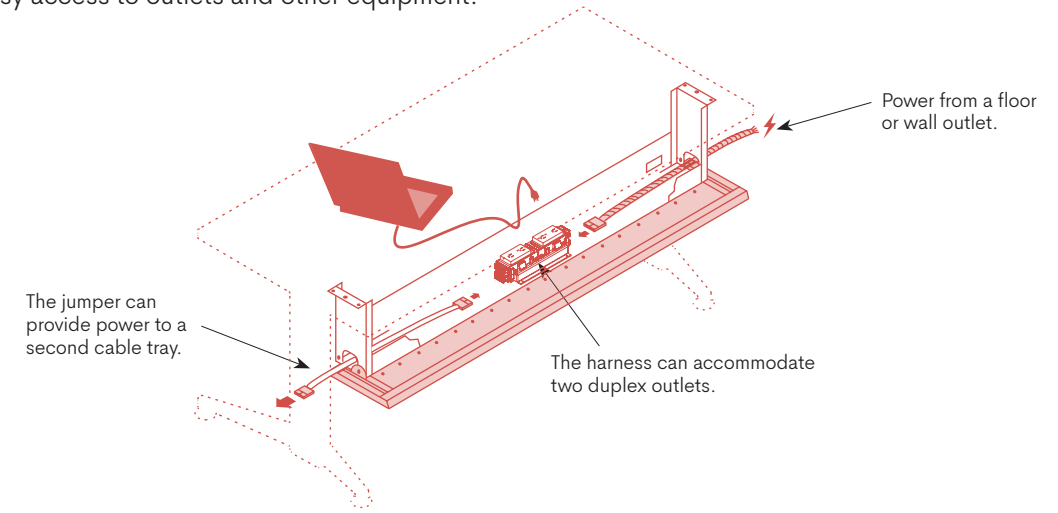

One-circuit electrical system

- Simple installation with no need for an electrician.
- Up to 8 surface outlets (16 individual outlets) can be connected to one system.
- Easy access to outlets and other equipment.

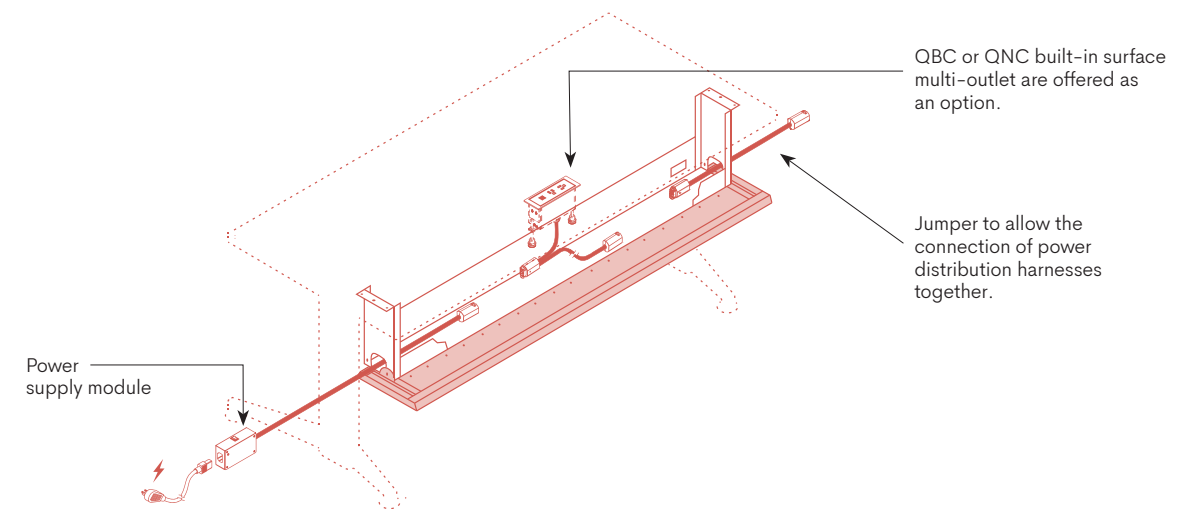

One-circuit electrical system

Can power up to eight tables on the same circuit.

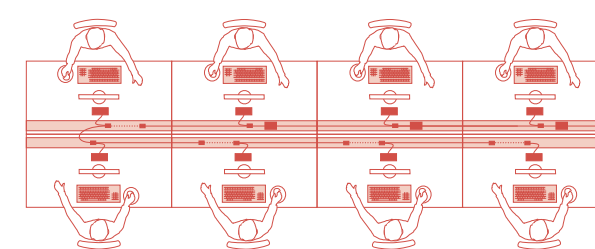

Four-circuit electrical system

Recommended for permanent installations.

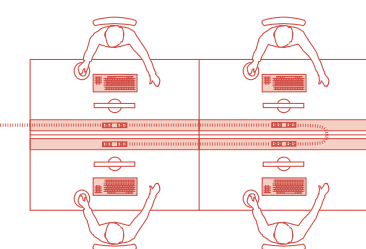

Typical Layouts

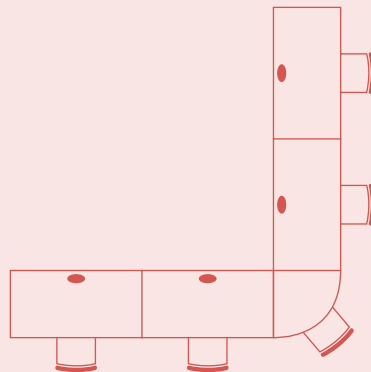
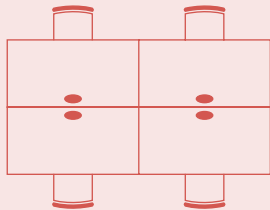
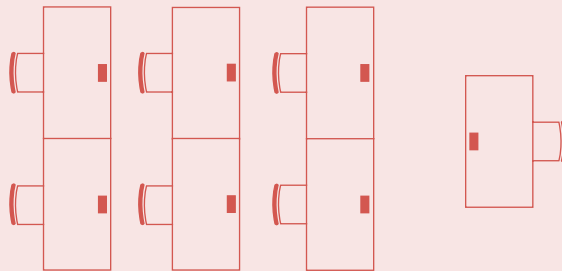
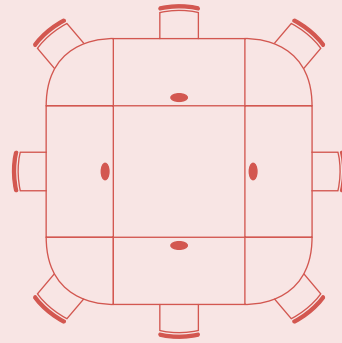
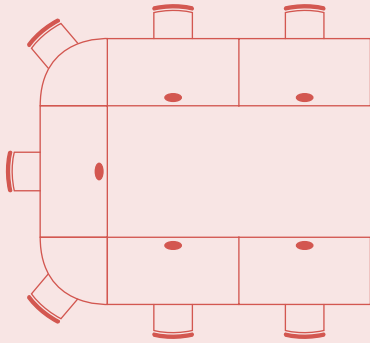

<p>ARTOPEX Head office artopex.com</p>	<p>800 Vadnais Street Granby, QC, Canada J2J 1A7 T 1 800 378 0189</p>
---	---

Standard Finish: [Link to website here](#)

Laminate / HPL – *Laminé / Stratifié*



Enamels / *Émaills*



Panel Fabrics / *Tissus Panneaux*



Seating / *Chaise* - Grades A, 1 & 2

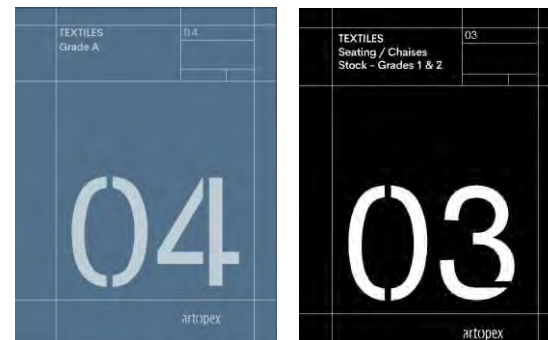

Pull Selection / *Sélection de poignées*



Aluminium (X)

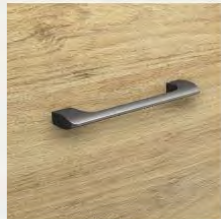

Antique Nickel (YA)



Brushed Bronze (YB)

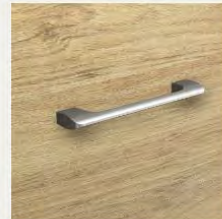

Brushed Nickel (YN)



Deco (DN)



Matte Black L shape (ML)



Matte Black Techno (MB)



Satin Chrome (J)



Techno (TN)



White L shape (WL)



White Techno (WT)

Grommet Color / *Couleur Passe-fil*



Black (G4)



Charcoal (G2)



Frost (G3)



White (G1)



Product Reference - Price List / Produits de référence - Liste de prix

Category / Catégorie	Product type / type de produit	Series / Séries (link)	Catalogue/price list link
Category 1 – Workstation Systems / Catégorie 1 - Systèmes De Poste De Travail	2.1.1 - INTERCONNECTING PANEL SYSTEMS / SYSTÈMES DE PANNEAUX INTERRACCORDABLES	Axel	Price list_Axel_GC_CAN.pdf
	2.1.1 - INTERCONNECTING PANEL SYSTEMS / SYSTÈMES DE PANNEAUX INTERRACCORDABLES	Accessories	Price List_Accessories_GC_CAN.pdf
	2.1.3 - SERVICE SPINE ("BEAM") SYSTEMS / SYSTÈMES DE COLONNE DE SERVICE (« POUTRE »)	Axel Beam	Price list_Axel_GC_CAN.pdf
Category 2 – Work Surface Products / Catégorie 2 : Produits Pour Les Surfaces De Travail	2.2.1 - FIXED HEIGHT WORK FREE-STANDING WORK SURFACES / SURFACES DE TRAVAIL AUTOPORTANTES À HAUTEUR FIXE	Take Off	Price list_Take Off_GC_CAN.pdf
	2.2.2 - HEIGHT ADJUSTABLE WORK SURFACES / SURFACES DE TRAVAIL À HAUTEUR RÉGLABLE	Take Off Adjustable Tables	Price list_Adjustables tables_GC_CAN.pdf
	2.2.3 - HEIGHT ADJUSTABLE WORKSURFACES WITH INTEGRATED CREDENZAS / SURFACES DE TRAVAIL À HAUTEUR RÉGLABLE AVEC CRÉDENZES INTÉGRÉES	Take Off Adjustable Tables	Price list_Adjustables tables_GC_CAN.pdf
	2.2.4 - WORK SURFACE TOPS FOR STORAGE UNITS / SURFACES DE TRAVAIL POUR DES UNITÉS DE RANGEMENT	Take Off	Price List_Take Off_GC_CAN.pdf
Category 3 - Filing And Storage Products / Catégorie 3 - Produits de classement et de rangement	2.3.1 - BAG DROPS / RANGEMENTS POUR SAC	Take Off	Price List_Take Off_GC_CAN.pdf
	2.3.2 - UNDERMOUNTED STORAGE CUBBIES / CUBES DE RANGEMENT ENCASTRÉS	Take Off	Price List_Take Off_GC_CAN.pdf
	2.3.3 - PEDESTALS / SOCLES	Take Off	Price List_Take Off_GC_CAN.pdf
	2.3.3 - PEDESTALS / SOCLES	Metal	Price list_Metal_GC_CAN.pdf
	2.3.4 - LATERAL FILING CABINETS / CLASSEURS LATÉRAUX	Take Off	Price List_Take Off_GC_CAN.pdf
	2.3.4 - LATERAL FILING CABINETS / CLASSEURS LATÉRAUX	Metal	Price list_Metal_GC_CAN.pdf
	2.3.5 - CREDENZAS / BAHUT	Take Off	Price List_Take Off_GC_CAN.pdf
	2.3.6 - HUTCHES / HUCHES	Take Off	Price List_Take Off_GC_CAN.pdf
	2.3.7 - BOOKCASES / BIBLIOTHÈQUES	Take Off	Price List_Take Off_GC_CAN.pdf
	2.3.7 - BOOKCASES / BIBLIOTHÈQUES	Metal	Price list_Metal_GC_CAN.pdf
	2.3.8 - PERSONAL STORAGE TOWERS / TOURS DE RANGEMENT POUR EFFETS PERSONNELS	Take Off	Price List_Take Off_GC_CAN.pdf
	2.3.8 - PERSONAL STORAGE TOWERS / TOURS DE RANGEMENT POUR EFFETS PERSONNELS	Metal	Price list_Metal_GC_CAN.pdf
	2.3.9 - SLIDE-OUT PERSONAL STORAGE TOWERS / TOURS DE RANGEMENT POUR EFFETS PERSONNELS COULISSANTES	Take Off	Price List_Take Off_GC_CAN.pdf
	2.3.10 - STORAGE CABINETS / ARMOIRES DE RANGEMENT	Take Off	Price List_Take Off_GC_CAN.pdf
	2.3.10 - STORAGE CABINETS / ARMOIRES DE RANGEMENT	Metal	Price list_Metal_GC_CAN.pdf
	2.3.11 - STORAGE LOCKERS / CASIERS DE RANGEMENT	Lockers	Price list_Lockers_GC_CAN.pdf
	2.3.12 - WARDROBES / GARDE-ROBES	Take Off	Price List_Take Off_GC_CAN.pdf
Category 4 - Phone Booths And Pods / Catégorie 4 : Cabines Téléphoniques Et Îlots	2.4.2 - INDIVIDUAL LOUNGE POD / FAUTEUIL D'ÎLOT INDIVIDUEL	Sc Lounge	Price list_Seating_Lounge_GC_CAN.pdf
	2.4.4 - GROUP WORK POD / ÎLOTS DE TRAVAIL COLLECTIF	Sc Lounge	Price list_Seating_Lounge_GC_CAN.pdf
Category 5 - Ancillary Products / Catégorie 5 : Produits Auxiliaires	2.5.2 - MONITOR ARMS / SUPPORTS DE MONITEUR	Express Program	Price list_Express program_GC_CAN.pdf
	2.5.3 - POWER MODULES / MODULES D'ALIMENTATION	Express Program	Price list_Express program_GC_CAN.pdf
	2.5.3 - POWER MODULES / MODULES D'ALIMENTATION	Accessories	Price List_Accessories_GC_CAN.pdf
	2.5.5 - WORK SURFACE PRIVACY SCREENS / ÉCRANS D'INTIMITÉ SUR UNE SURFACE DE TRAVAIL	Take Off	Price List_Take Off_GC_CAN.pdf
	2.5.5 - WORK SURFACE PRIVACY SCREENS / ÉCRANS D'INTIMITÉ SUR UNE SURFACE DE TRAVAIL	Accessories	Price List_Accessories_GC_CAN.pdf
Category 6 - Collaborative Products / Catégorie 6 : Produits De Collaboration	2.6.1 - MEETING TABLES (for formal spaces) / TABLE DE RÉUNION (pour les espaces formels)	Take Off Conference	Price list_Take Off Conference & Tables_GC_CAN.pdf
	2.6.2 - MULTI-TIER TABLES / TABLES MULTINIVEAUX	Take Off Conference	Price list_Take Off Conference & Tables_GC_CAN.pdf
	2.6.3 - COLLABORATIVE MEETING TABLES (for informal spaces) / TABLES DE RÉUNION COLLABORATIVE (pour les espaces informels)	Take Off Conference	Price list_Take Off Conference & Tables_GC_CAN.pdf
	2.6.3 - COLLABORATIVE MEETING TABLES (for informal spaces) / TABLES DE RÉUNION COLLABORATIVE (pour les espaces informels)	Downtown	Price list_Downtown_GC_CAN.pdf
	2.6.4 - OCCASIONAL TABLES (COFFEE and SIDE TABLES) / TABLES FONCTIONNELLES (TABLES DE CAFÉ ET TABLES D'APPOINT)	Take Off Conference	Price list_Take Off Conference & Tables_GC_CAN.pdf
	2.6.5 - CONSOLE TABLES (NARROW and ISLAND TABLES) / CONSOLES (TABLES ÉTROITES ET ÎLOTS)	Take Off Conference	Price list_Take Off Conference & Tables_GC_CAN.pdf
	2.6.5 - CONSOLE TABLES (NARROW and ISLAND TABLES) / CONSOLES (TABLES ÉTROITES ET ÎLOTS)	Downtown	Price list_Downtown_GC_CAN.pdf
	2.6.6 - TRAINING ROOM TABLES / TABLES DE SALLE DE FORMATION	Genius Tables	Price list_Genius tables_GC_CAN.pdf
	2.6.6 - TRAINING ROOM TABLES / TABLES DE SALLE DE FORMATION	Accessories	Price List_Accessories_GC_CAN.pdf
	2.6.7 - LAPTOP TABLES / TABLES POUR ORDINATEUR PORTABLE	Take Off Conference	Price list_Take Off Conference & Tables_GC_CAN.pdf
	2.6.7 - LAPTOP TABLES / TABLES POUR ORDINATEUR PORTABLE	Downtown	Price list_Downtown_GC_CAN.pdf
	2.6.8 - VIDEO CONFERENCING TABLES / TABLES DE VIDÉOCONFÉRENCE	Take Off Conference	Price list_Take Off Conference & Tables_GC_CAN.pdf
	2.6.9 - MULTI-MEDIA TABLES / TABLES MULTIMÉDIAS	Take Off Conference	Price list_Take Off Conference & Tables_GC_CAN.pdf
	2.6.10 - BANQUETTES / BANQUETTES	Seating / Lounge	Price list_Seating_Lounge_GC_CAN.pdf
	2.6.10 - BANQUETTES / BANQUETTES	Downtown	Price list_Downtown_GC_CAN.pdf
	2.6.11 - BAR STOOLS / TABOURETS DE BAR	Seating / Lounge	Price list_Seating_Lounge_GC_CAN.pdf
	2.6.12 - BENCHES / BANCS	Seating / Lounge	Price list_Seating_Lounge_GC_CAN.pdf
	2.6.13 - KITCHENETTE CHAIRS / CHAISES DE CUISINETTE	Seating / Lounge	Price list_Seating_Lounge_GC_CAN.pdf
	2.6.14 - LOUNGE CHAIRS / FAUTEUIL D'AIRE REPOS	Seating / Lounge	Price list_Seating_Lounge_GC_CAN.pdf
	2.6.15 - MODULAR SOFT SEATING / SIÈGE MODULAIRE REMBOURRÉ	Seating / Lounge	Price list_Seating_Lounge_GC_CAN.pdf
2.6.15 - MODULAR SOFT SEATING / SIÈGE MODULAIRE REMBOURRÉ	Downtown	Price list_Downtown_GC_CAN.pdf	
2.6.16 - SOFAS / SOFAS	Seating / Lounge	Price list_Seating_Lounge_GC_CAN.pdf	
2.6.16 - SOFAS / SOFAS	Downtown	Price list_Downtown_GC_CAN.pdf	
2.6.17 - TABLE ARM CHAIRS / FAUTEUILS ACCOUDOIR À TABLETTE	Seating / Lounge	Price list_Seating_Lounge_GC_CAN.pdf	
2.6.17 - TABLE ARM CHAIRS / FAUTEUILS ACCOUDOIR À TABLETTE	Downtown	Price list_Downtown_GC_CAN.pdf	
2.6.18 - OTTOMANS AND STOOLS / POUFS ET TABOURETS	Downtown	Price list_Downtown_GC_CAN.pdf	
2.6.19 - LOUNGE SCREENS / ÉCRANS D'AIRES DE REPOS	Seating / Lounge	Price list_Seating_Lounge_GC_CAN.pdf	
2.6.19 - LOUNGE SCREENS / ÉCRANS D'AIRES DE REPOS	Downtown	Price list_Downtown_GC_CAN.pdf	
2.6.20 - MOBILE DISPLAY UNITS / UNITÉ D'AFFICHAGE MOBILE	Seating / Lounge	Price list_Seating_Lounge_GC_CAN.pdf	
2.6.20 - MOBILE DISPLAY UNITS / UNITÉ D'AFFICHAGE MOBILE	Downtown	Price list_Downtown_GC_CAN.pdf	
2.6.21 - MOBILE DRY ERASE BOARDS / ÉCRANS D'AIRES DE REPOS	Downtown	Price list_Downtown_GC_CAN.pdf	
2.6.22 - RECYCLING CENTERS / CENTRES DE RECYCLAGE	Take Off	Price List_Take Off_GC_CAN.pdf	